

AI-TALL WOOD STORAGE XL

terrain

Assembly Instructions

TOOLS REQUIRED BUT NOT INCLUDED: None

WARNINGS:

Do not throw away packing materials and carton until after assembly.
Ensure all parts are present prior to assembly.
Contact customer service immediately if parts are missing.
Assemble all parts on a clean smooth surface.

FIREPLACE INTENDED FOR OUTDOOR USE ONLY!

Do Not place Fireplace on wood surfaces
Do Not use under low tree limbs
Do Not use near walls
Do Not use near Shrubs or Bushes
Do Not burn fires near flammable materials
Do Not overfill with wood
Do Not leave fire unattended
Do Not allow children and pets near the Fireplace without supervision.
Do Not touch the fireplace while lit or shortly after extinguishing.
Check the weather before lighting a fire.
Check local fire laws.

CARE INSTRUCTIONS:

You may need to re-tighten all bolts after initial use.
Clean the Fireplace after every use.
Blot spills with a clean towel.
Before cleaning test a small spot Use only untreated wood and logs.
Do Not use water to extinguish fire as it can damage.
Do Not clean with harsh chemicals.

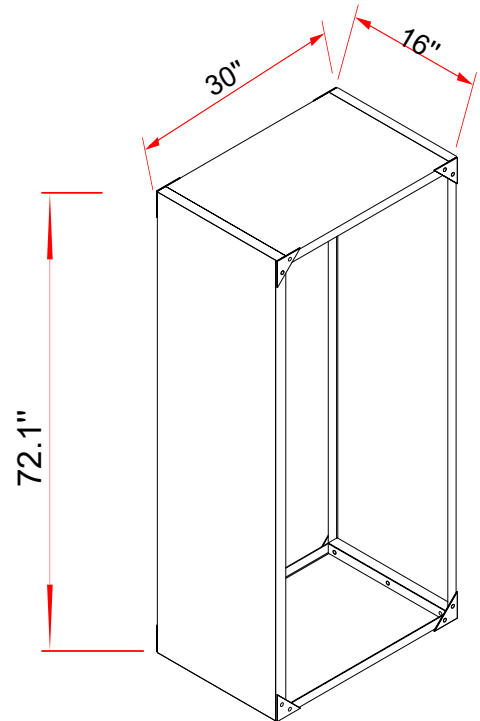

PARTS INCLUDED:

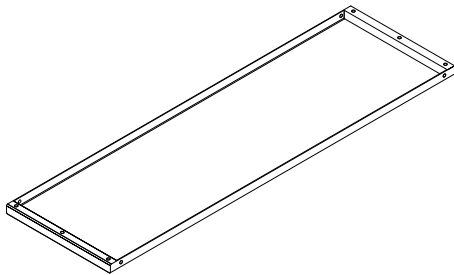

(A) Side Panel x2

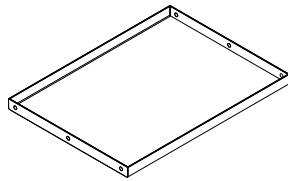

(B) Shelf x2

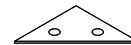

(C) Triangle Plate x8



(D) Bolt
[M8x10mm] x28

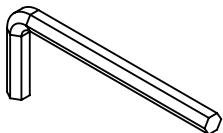

(E) Hex key x1

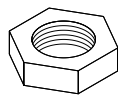

(F) Nut x16

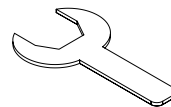

(G) Nut key x1

Assembly Instructions

STEP 1 Align the Shelves (B) with one Side Panels (A) as shown. Insert Bolts (D) and partially tighten, then tighten all bolts fully. See below picture for details.

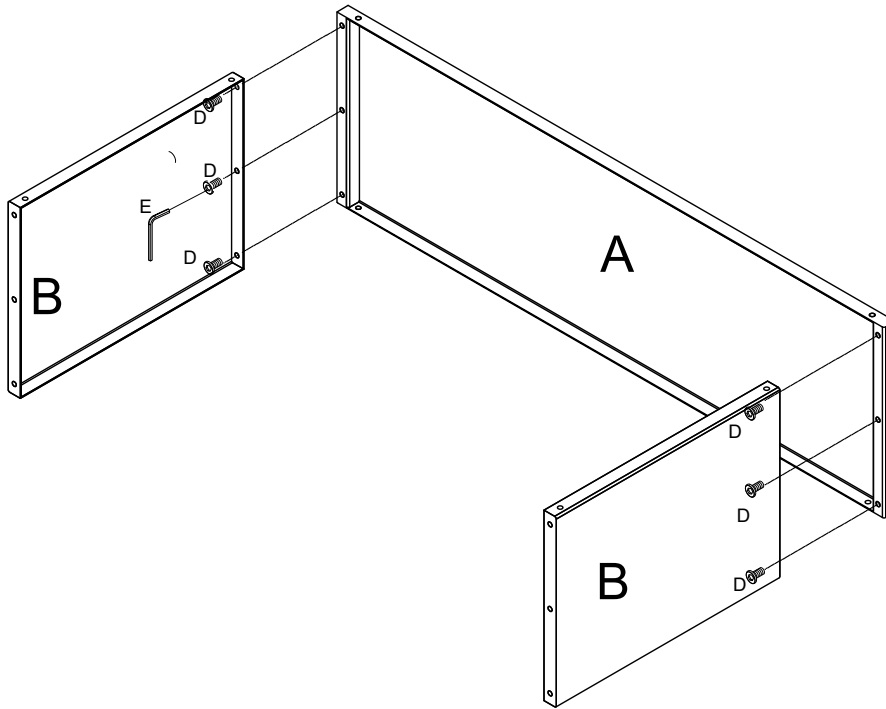

STEP 2 Align the other Side Panel (A) with Shelves (B) as shown. Insert Bolts (D) and partially tighten, then tighten all bolts fully. See below picture for details.

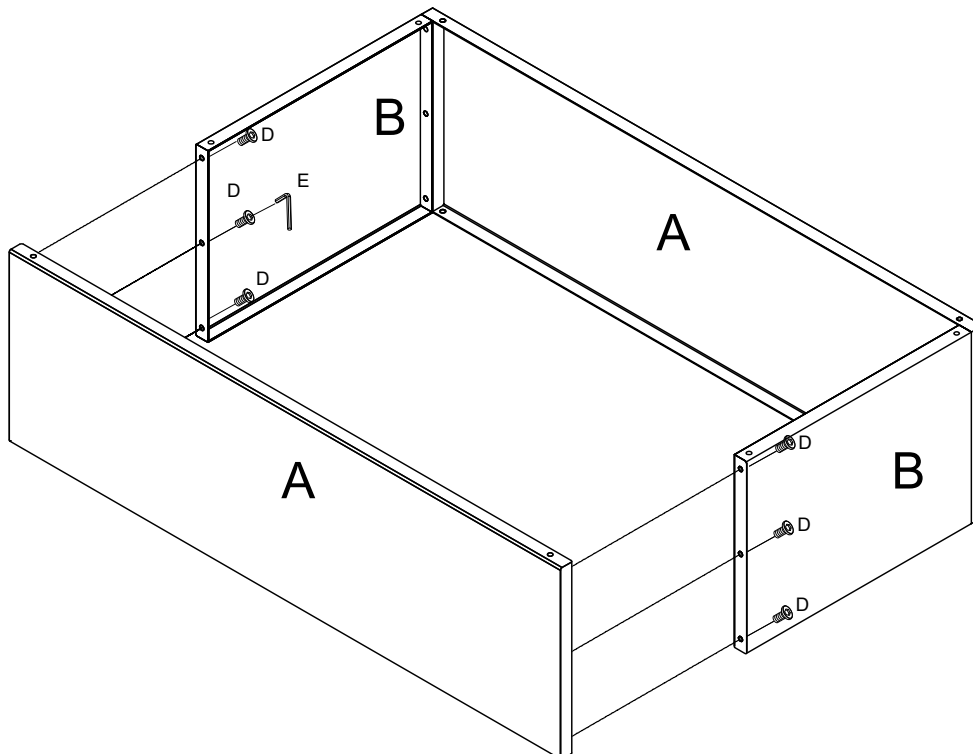

AI-TALL WOOD STORAGE XL

terrain

Assembly Instructions

STEP 3 Align Triangle Plates (C) with body as shown. Insert Bolts (D) and partially tighten, then tighten all bolts fully. See below picture for details.

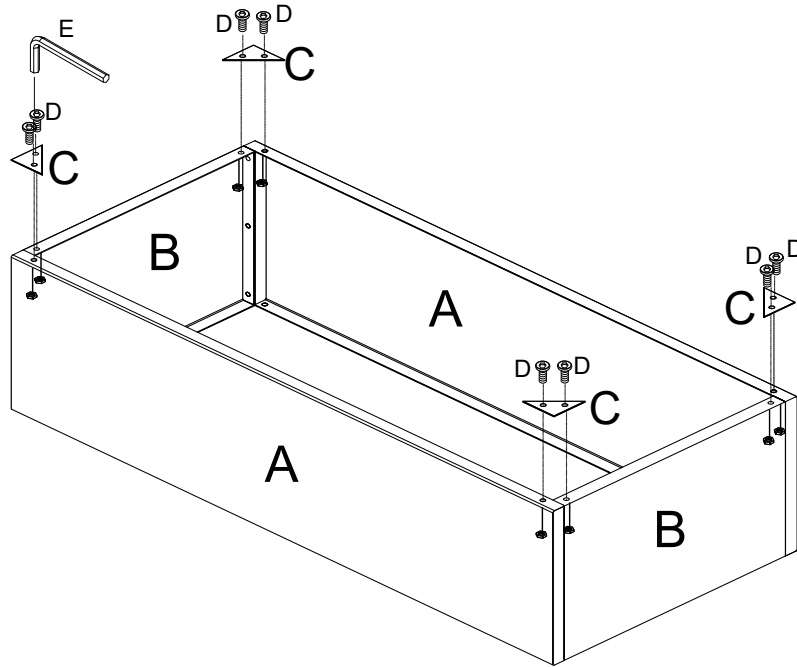

STEP 4 Turn over the body. And align the rest Triangle Plates (C) with body as shown. Insert Bolts (D) and partially tighten, then tighten all bolts fully. See below picture for details.

